



# Sampson Mills

*Window Treatments & Spatial Dividers*

SUSPENSION|CEILING|WALL|SIDEWALL

# CUBICLE

*Where your creativity can flourish with our ingenuity.*

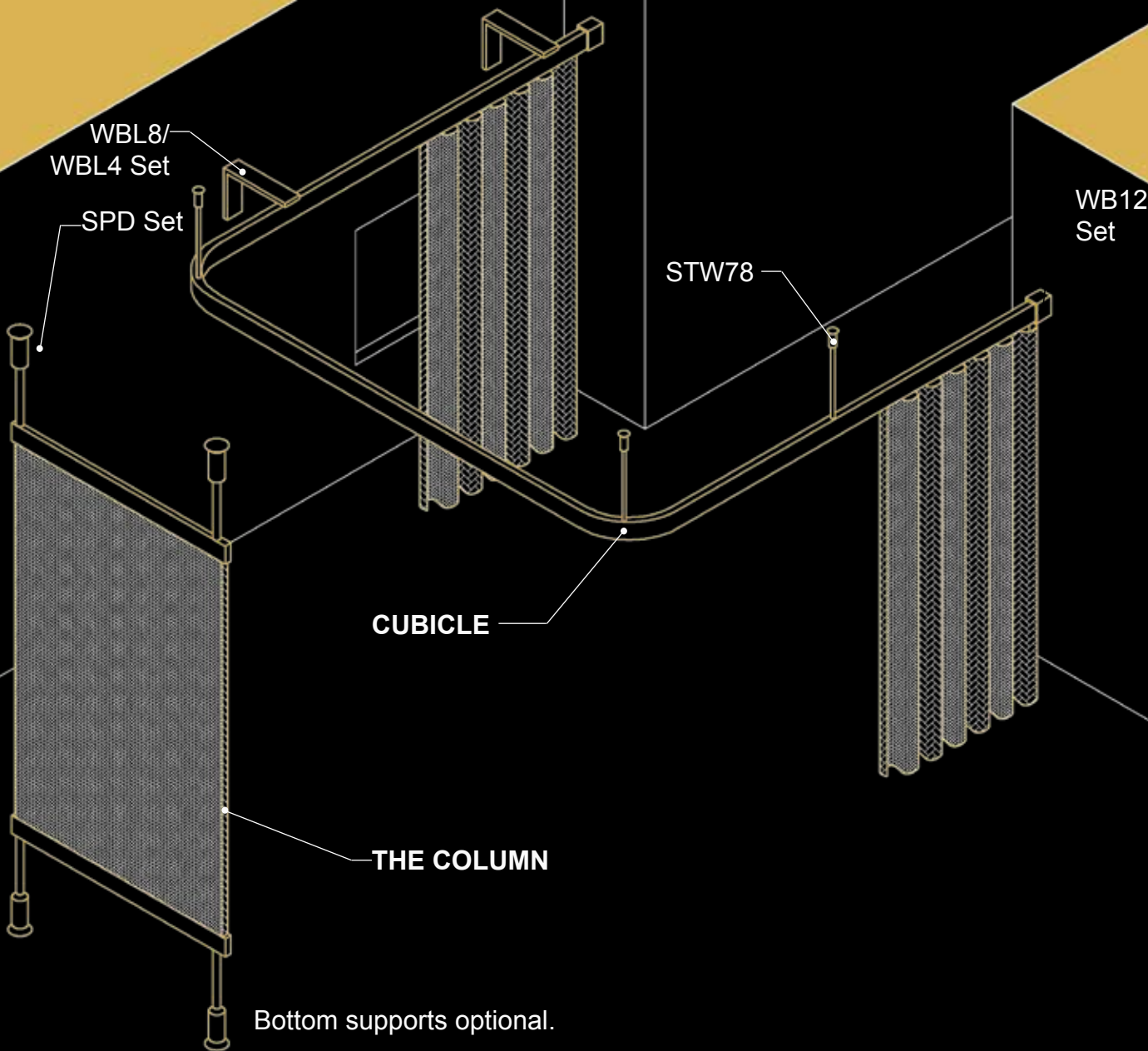

## THE COLUMN

Stationary solution for spatial dividing and acoustical panels. Also suitable for areas with air flow, such as next to AC Vents or doorways. Bottom supports recommended for air flow applications.

Compatible with tracks SF90 and SF120.

## CUBICLE

Spatial dividing solutions for Hospitality, Healthcare and Commercial spaces. When used together with anti-microbial materials it can help reduce the spread of bacteria and viruses, while still retaining an open concept design.

Compatible with track F120.



**SF90**

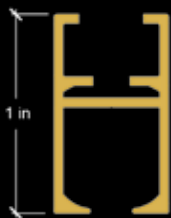

**SF120/ F120 - Suspension/ Wall Mount**

System can be mounted with adjustable suspension rods and tension cable to get around uneven ceilings or duct work.

SF90 and SF120 Stationary Panel Track.

F120 for Curtain Track and Cubicle applications.

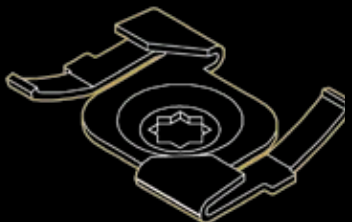
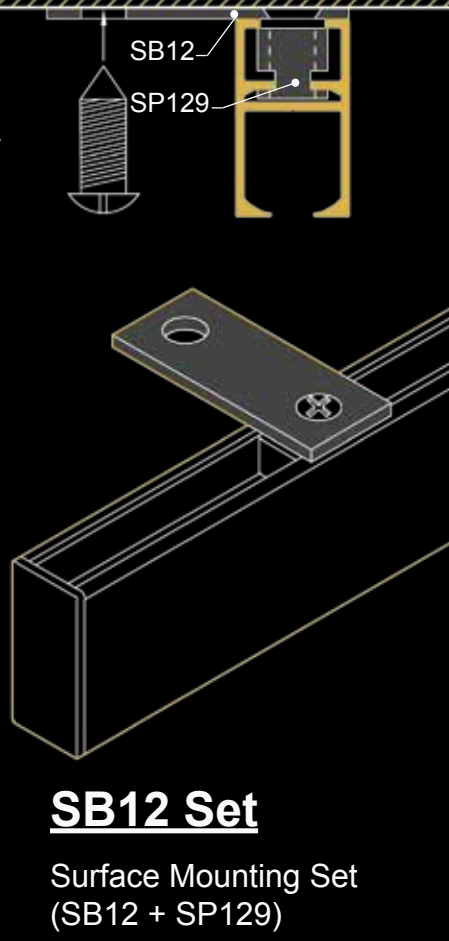
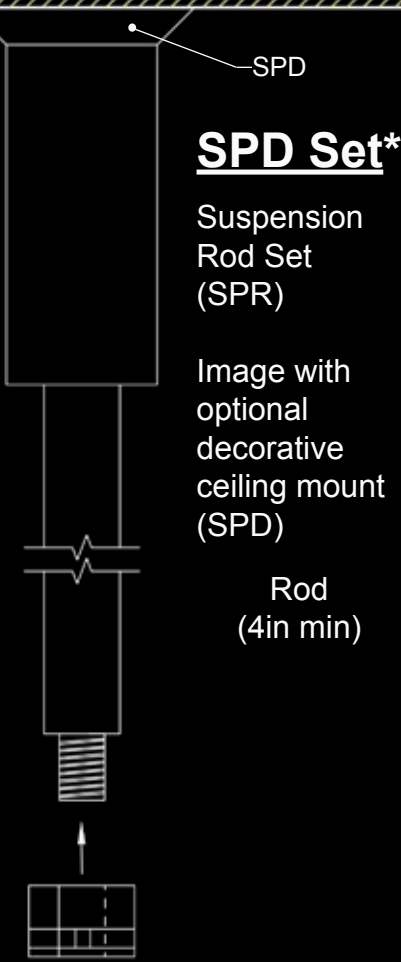
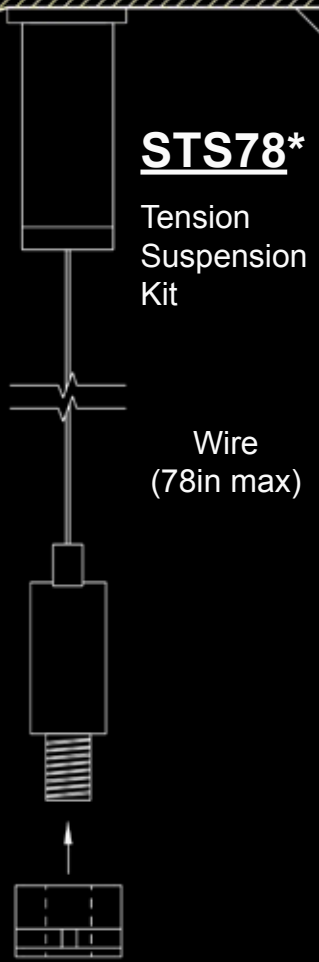
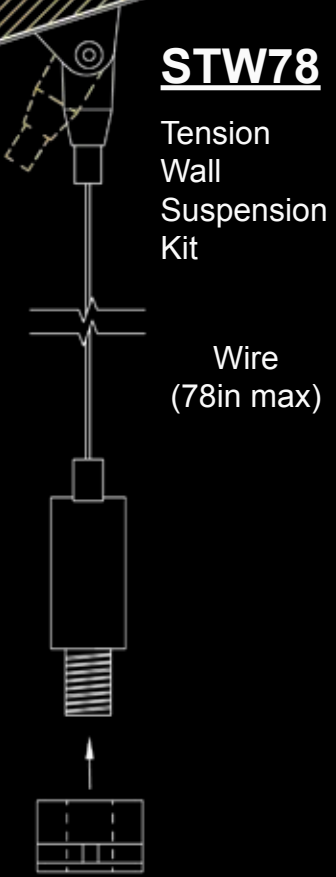

**ZC01**  
\*Optional Z-Clip for drop ceiling scenarios.



**SP129**  
Universal mounting nut.

**WB12 Set**  
Side Wall Bracket (WB12 + SP129)

**WBL8 Set**  
8in Wall Bracket (WBL8 + SP129)

**WBL4 Set**  
4in Wall Bracket (WBL4 + SP129)

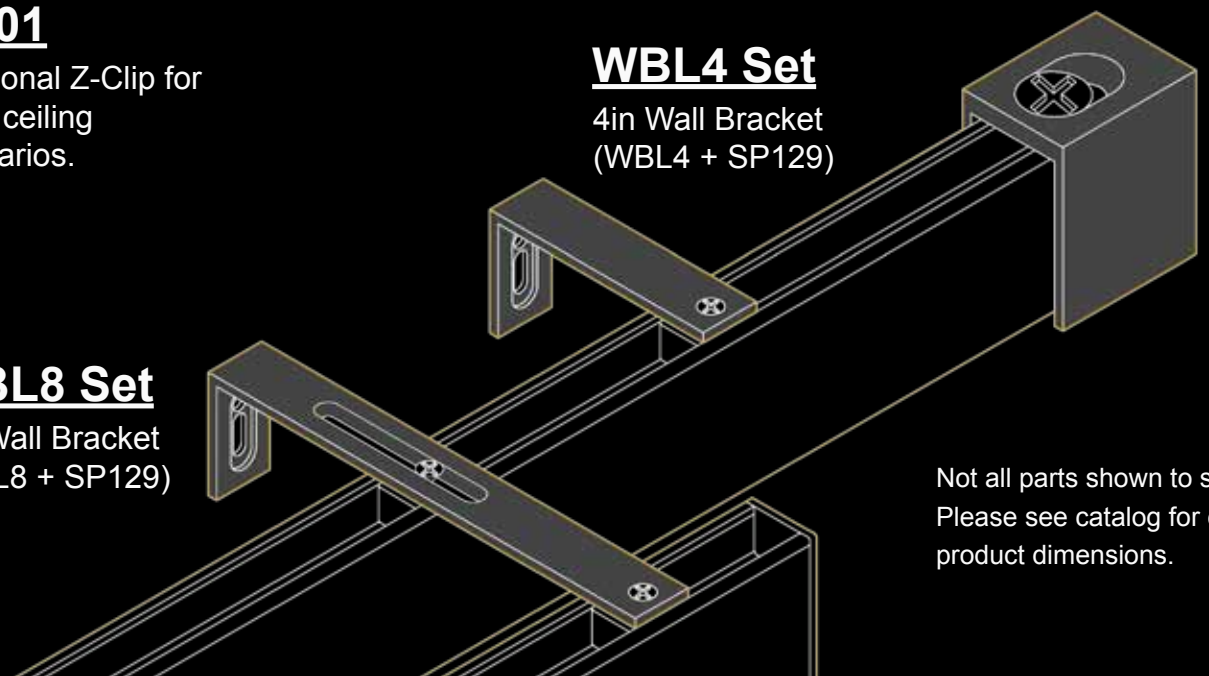

Not all parts shown to scale. Please see catalog for exact product dimensions.

## Development Program

*Please call or email us if you would like to utilize our Development Program for either private label, consulting services, or a request for product development.*

*Where your  
creativity can  
flourish with  
our ingenuity.*

### **Sampson Mills Ltd.**

Showroom:  
D&D Building  
979 3rd Ave, Suite 1540  
New York NY 10022

Assembly:  
810 East 141st Street, 3rd Flr.  
Bronx, NY, 10454

T (718) 412-9040  
F (718) 412-9039  
[www.sampsonmills.com](http://www.sampsonmills.com)

