

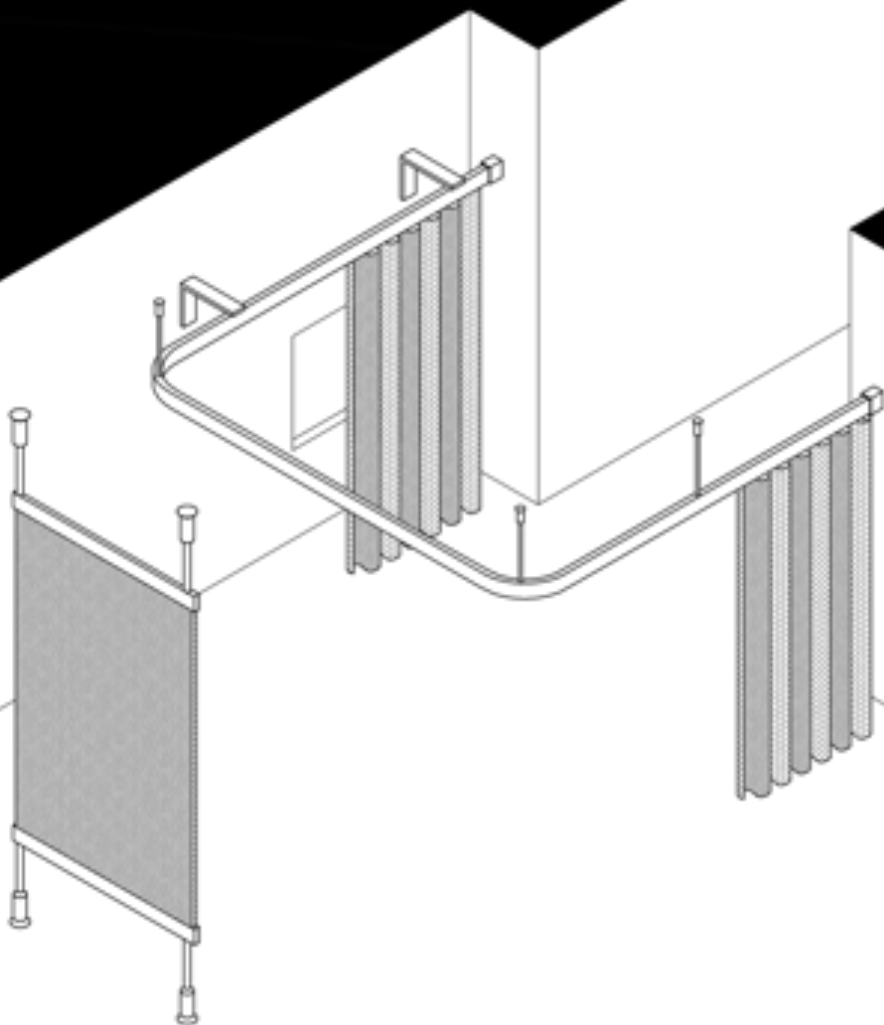

Sampson Mills



**Window Treatments
&
Room Dividers**





Quick Links



Website



Instagram



TikTok



3-Part Spec



**Curtain
Brochures**



**Panel
Brochures**



**Installation
Videos**



**Development
Program**

Index

Curtain Tracks Page 1-4

F16
 Recessed curtain track with wings for mudding into ceiling.

FS16
 Ceiling mounted curtain track

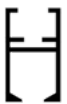
F120
 Suspended and Wall Mounted curtain track



Gemini Profile Page 7-8

 BF121R

 BF121

 BF120

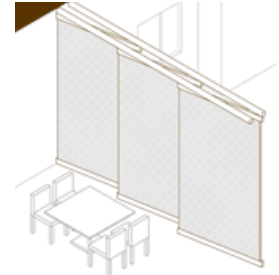

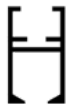
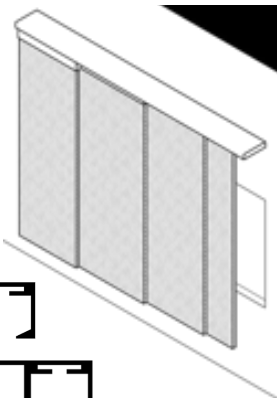

*Including Baffle System

Shuttle Profile Page 5

PF120
 

PF121R

PF121

PF122

PF123

PF124

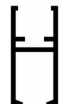
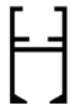
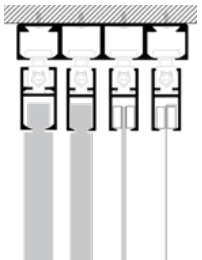

PF125

Shuttle Carrier Gemini Carrier

PFB90 PFB12
 Can work with a range of sizes. See brochure for details.

Column Profile Page 6

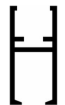

SF90 SF120



Sampson Mills

Curtain Style

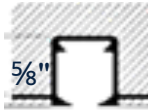

F16 - Recessed curtain track with wings for mudding into ceiling.

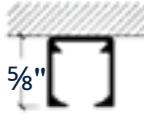
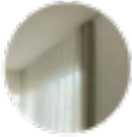

FS16 - Ceiling mounted curtain track

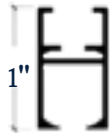

F120 - Suspended and Wall Mounted curtain track



Grommet Add on (Optional)



Grommet Add on (Optional)

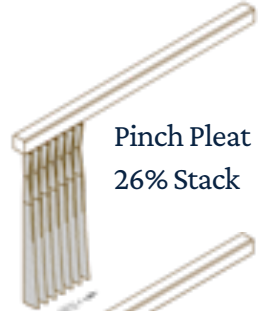
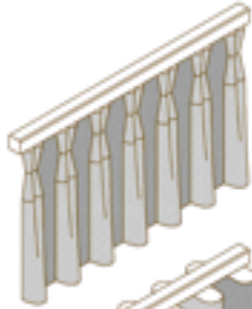

Pinch Pleat
26% Stack

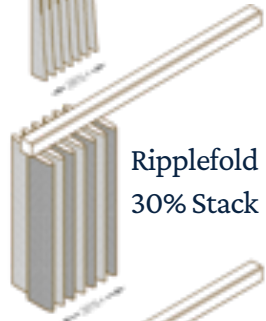

Ripplefold
30% Stack



S-Fold
18% Stack
On Site Adjustability



F16 - Recessed curtain track with wings for mudding into ceiling.



Minimum Radius 10"
Standard Radius 10"
No Maximum Radius

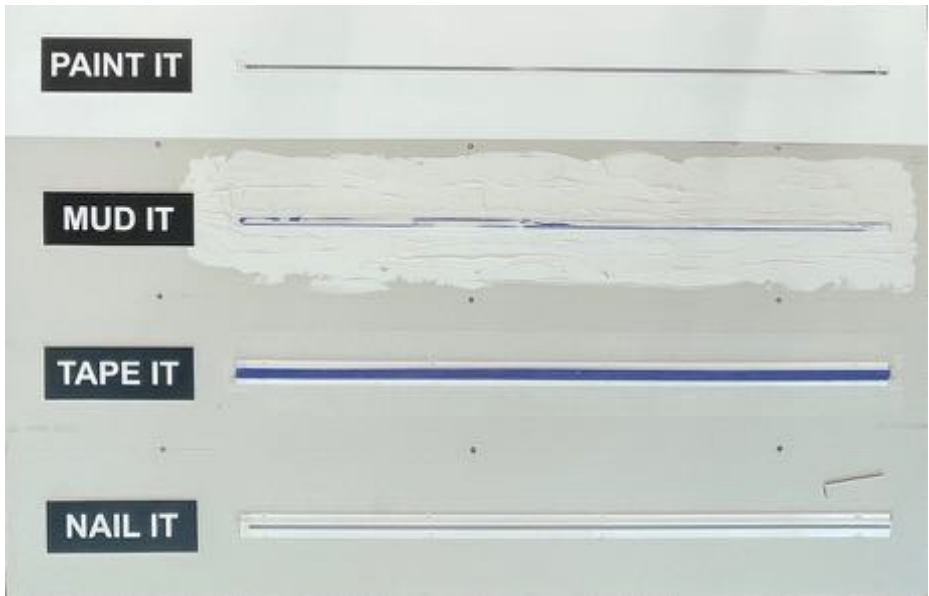
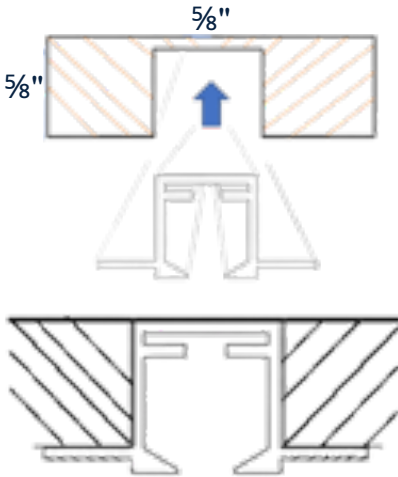

Sampson Mills

FS16 - Ceiling mounted curtain track



Minimum Radius 4"
Standard Radius 10"
No Maximum Radius



Sampson Mills

F120 - Suspended, Wall & Ceiling Mounted Curtain track



Minimum Radius 10"
Standard Radius 10"
No Maximum Radius

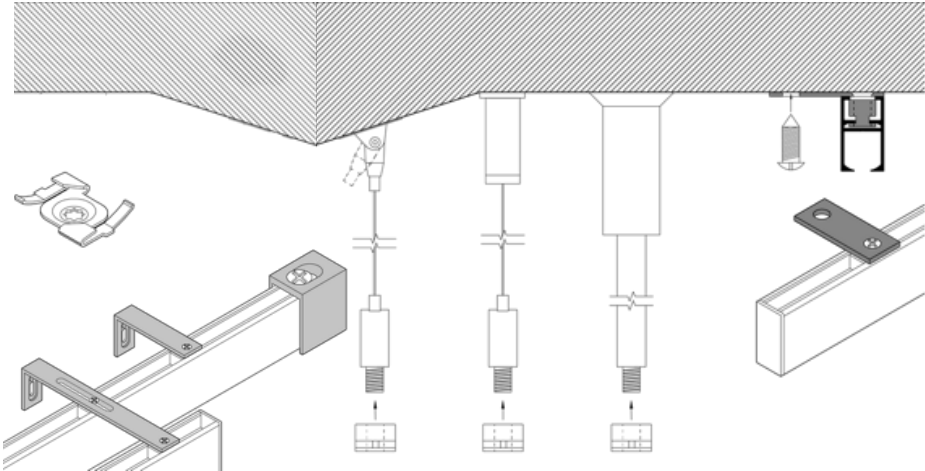

Sampson Mills

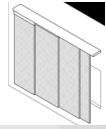

Shuttle Profile

Suspend/Wall Mount/Ceiling Mount

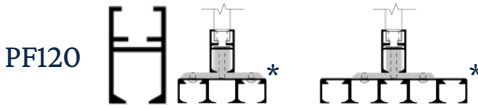

Recess



Ceiling Mount



*Tracks can be suspended when connecting to PF120

Shuttle Carrier

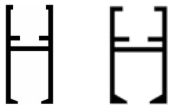

PFB90 PFB12

Can work with a range of sizes. See brochure for details.

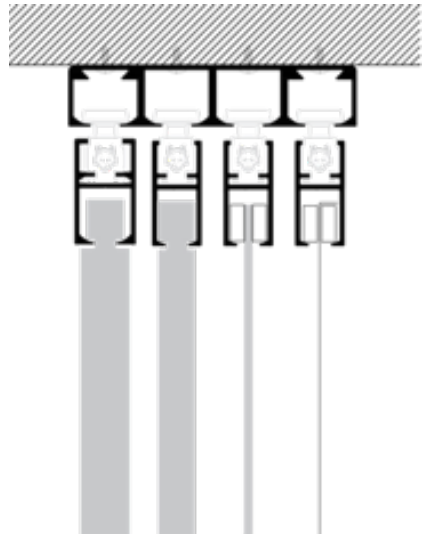

For Fabrics and materials under 5 mm thickness use our 2 strip solution for mounting your material.



Sampson Mills

Column Profile

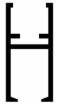

SF90



SF120



Minimum Radius 10"
Standard Radius 10"
No Maximum Radius

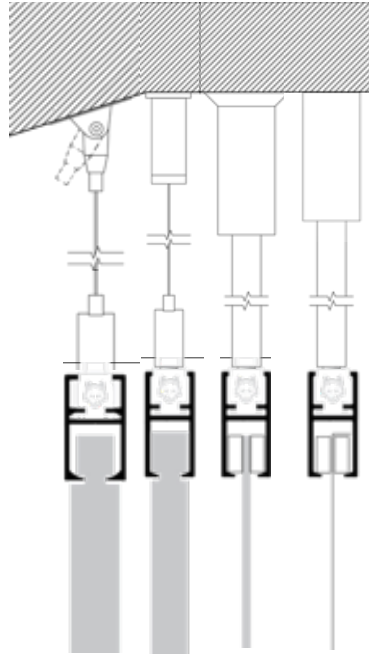

Can work with a range of sizes.
See brochure for details.

Utilize our Locke option to reduce tension on open weave materials like fish net materials helping to avoid the hourglass shape and reducing stretching in your fabric.

See brochure for details.

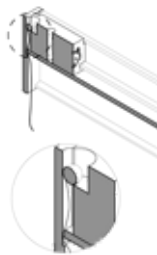

Sampson Mills

Gemini Profile



Minimum Radius 10"
 Standard Radius 10"
 No Maximum Radius

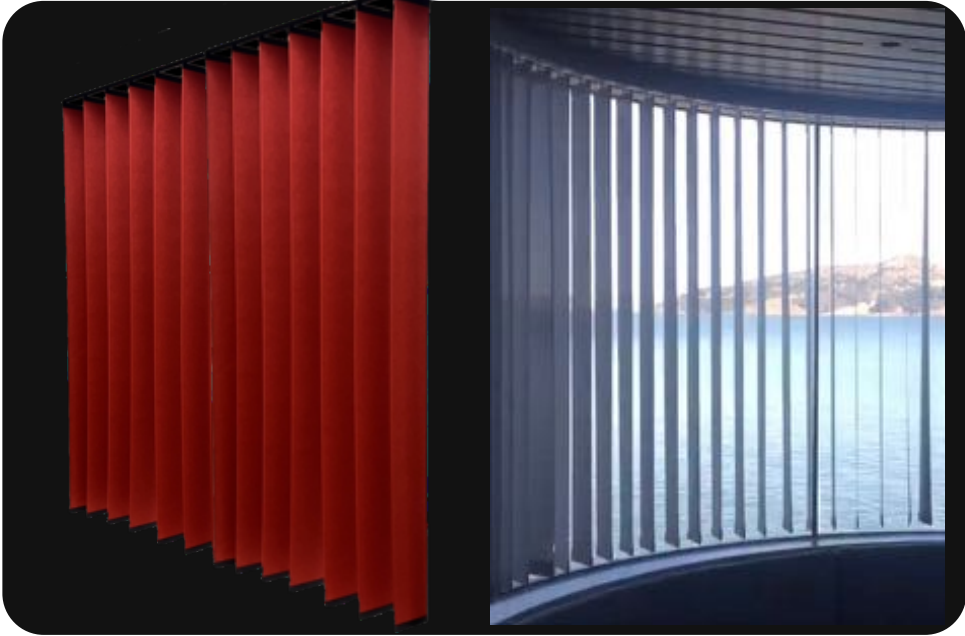
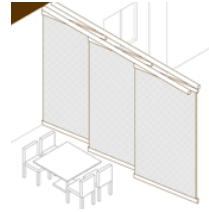

Gemini Carrier

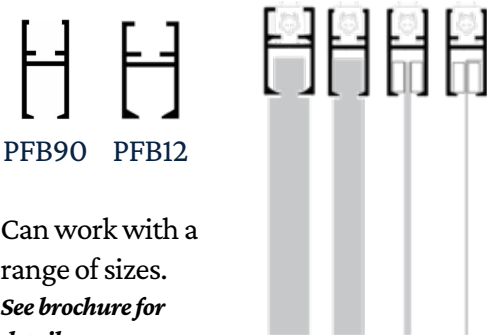

Can work with a range of sizes.
 See brochure for details.



Gemini Baffle Profile



Minimum Radius 10"
Standard Radius 10"
No Maximum Radius

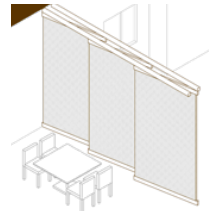

Gemini Carrier

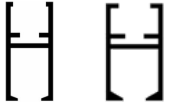

PFB90 PFB12

Can work with a range of sizes. See brochure for details.

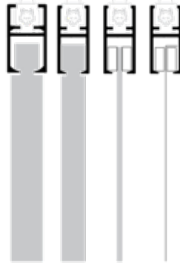

The Gemini Baffle

Great for skylights, exposed ceilings, music studios or just to help with the echo in your open room.



Sampson Mills



Sampson Mills

(718) 412-9040

www.Sampsonmills.com

Info@sampsonmills.com